

BIKE PROJECT

MTB HYDRAULIC SOLUTIONS



www.gapigroup.com



BRAKE LEVERS

FORK

SEAT POST



SHOCK

BRAKE SYSTEM

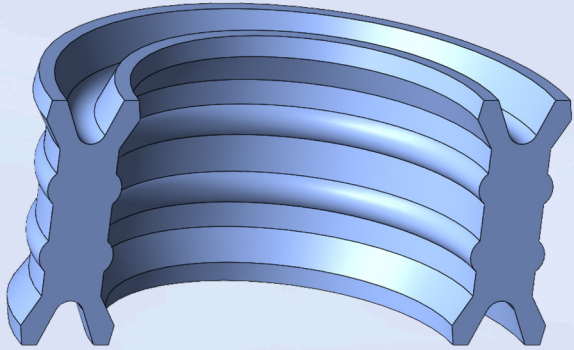

FLOATING PISTON

Material: TPU 85 Shore A

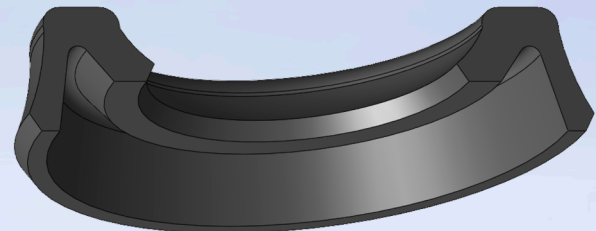

LOW FRICTION ROD SEAL

Material: TPU 85 Shore A
Graphite filled

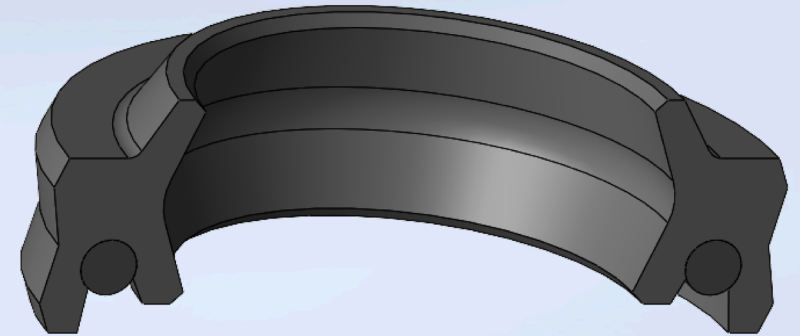

**ENERGIZED BIDIRECTIONAL
WIPER**

Combined Material:

- TPU 90 Shore A Graphite filled
- NBR 70 Shore A (Energizing O-Ring)

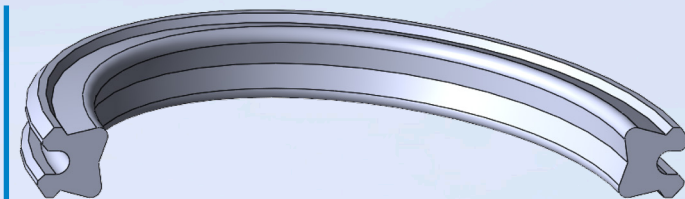

LOW FRICTION PISTON SEAL
Material: TPU 90 Shore A

LOW FRICTION ROD SEAL
Material: TPU 90 Shore A
Graphite filled

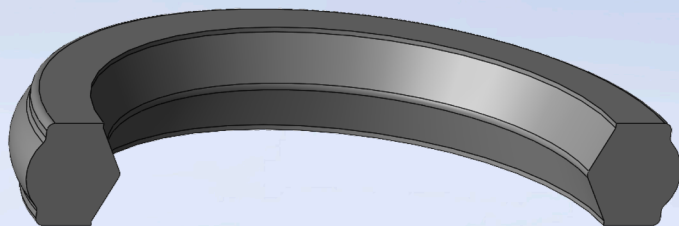

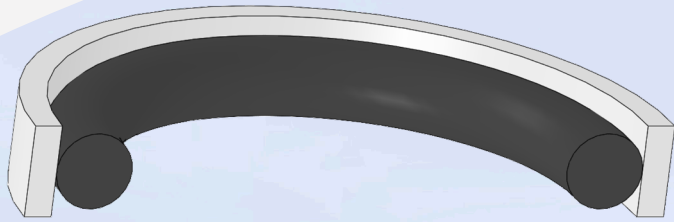

LOW FRICTION PISTON SEAL

Combined Material:

- PBT Natural
- NBR 70 Shore A (Energizing O-Ring)

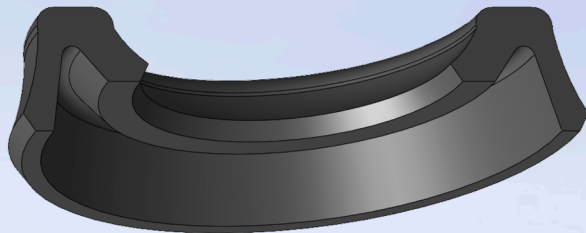

LOW FRICTION ROD SEAL

Material: TPU 85 Shore A
Graphite filled

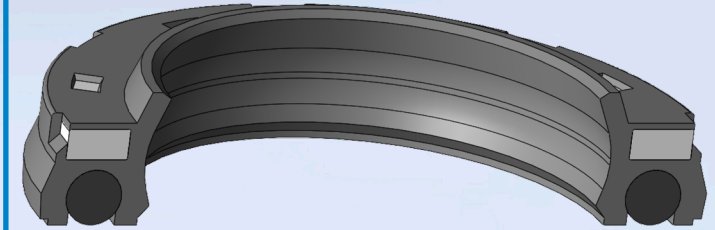

ENERGIZED BIDIRECTIONAL WIPER

Combined Material:

- TPU 90 Shore A Graphite filled
- NBR 70 Shore A (Energizing O-Ring)
- Steel (Metal Insert)

SECONDARY SEAL
Material: SBR - EPDM

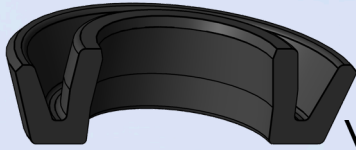

PRIMARY SEAL
Material: SBR-EPDM

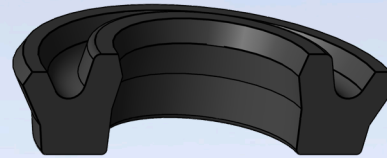

TANK DIAPHRAGM
Material: SBR-EPDM

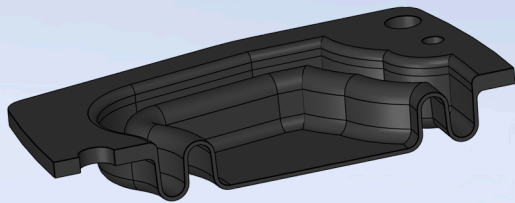

DUST HEADCAP
Material: SBR - EPDM

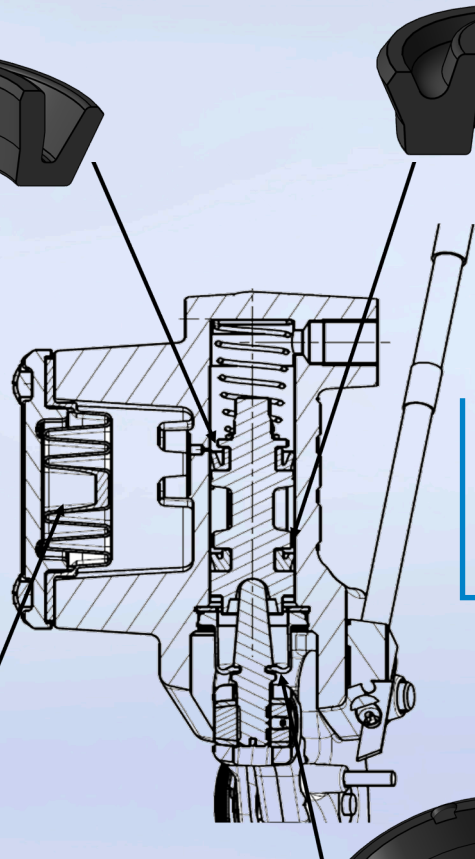
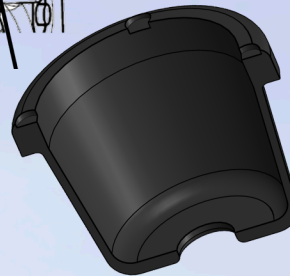

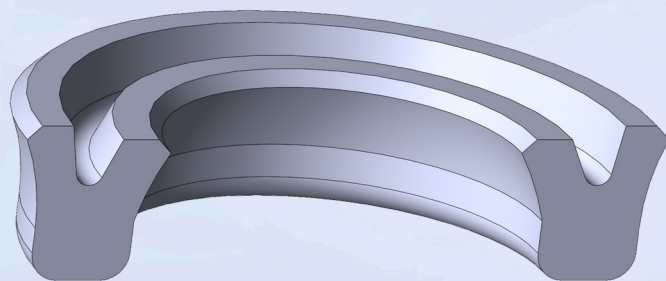

ROD SEAL
Material: TPU 90 Shore A



www.gapigroup.com